

ALPHABET SHAPES

Find Spellings

Alpana Jain

Alpanaj21@gmail.com, alpanajain@diverselearningneeds.com

Name: _____

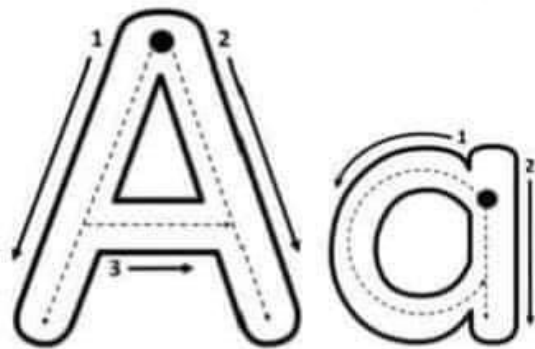
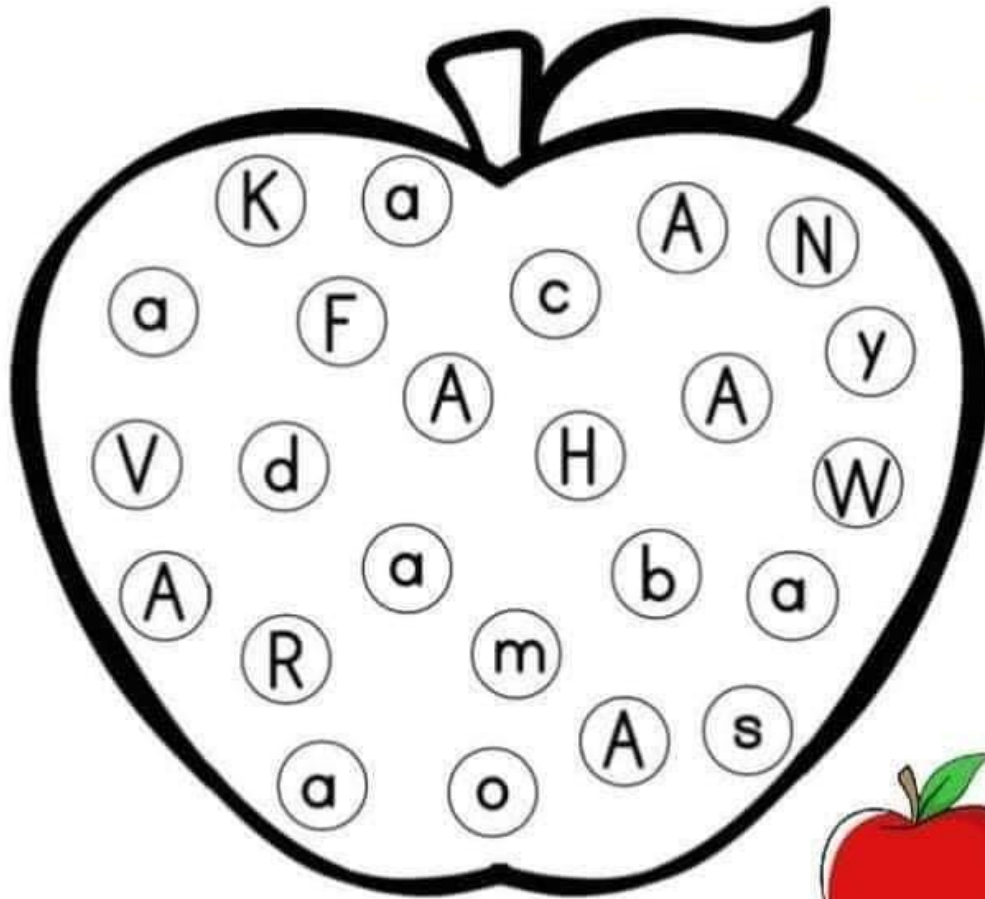

apple

Name: _____

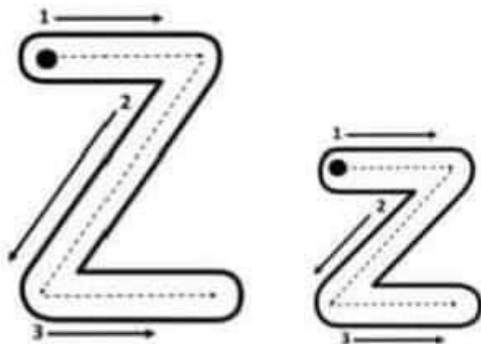
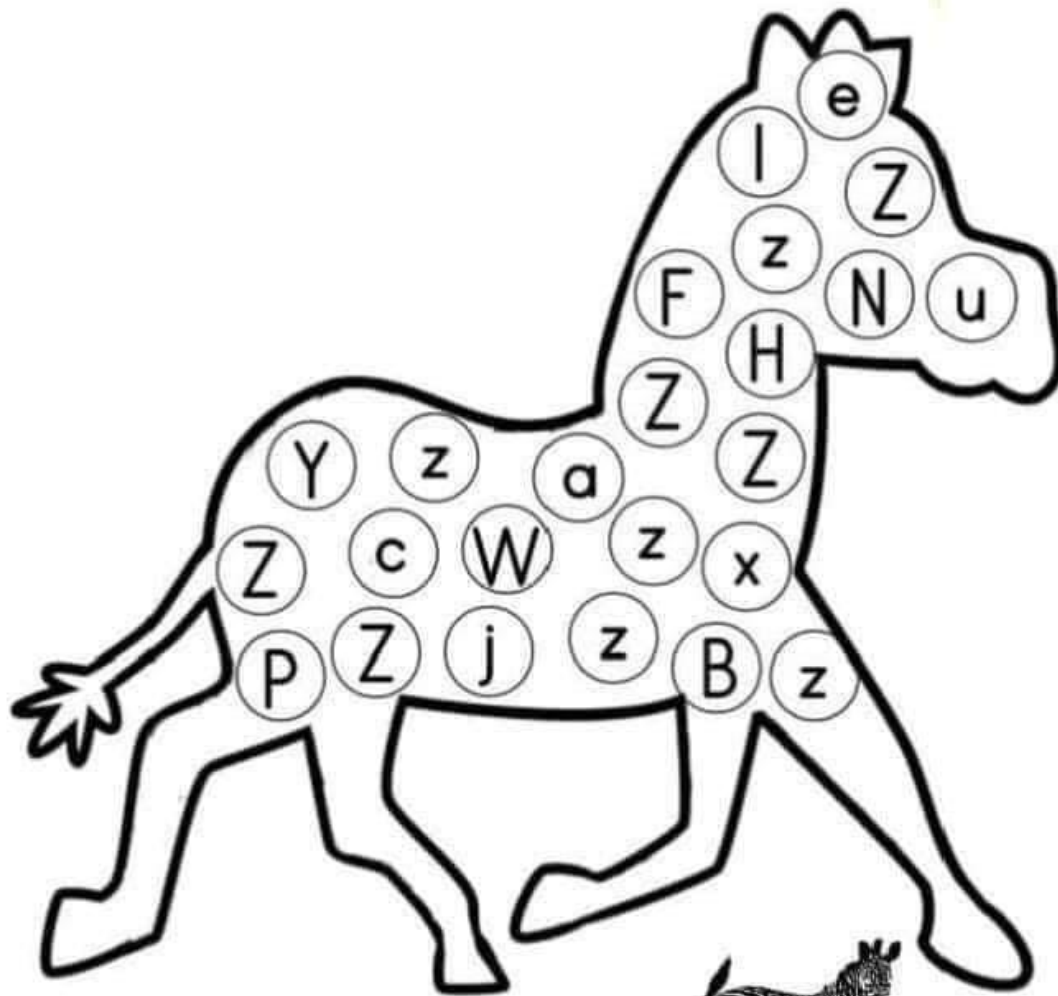

zebra

Name: _____

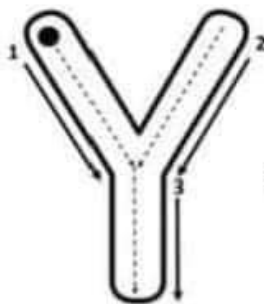
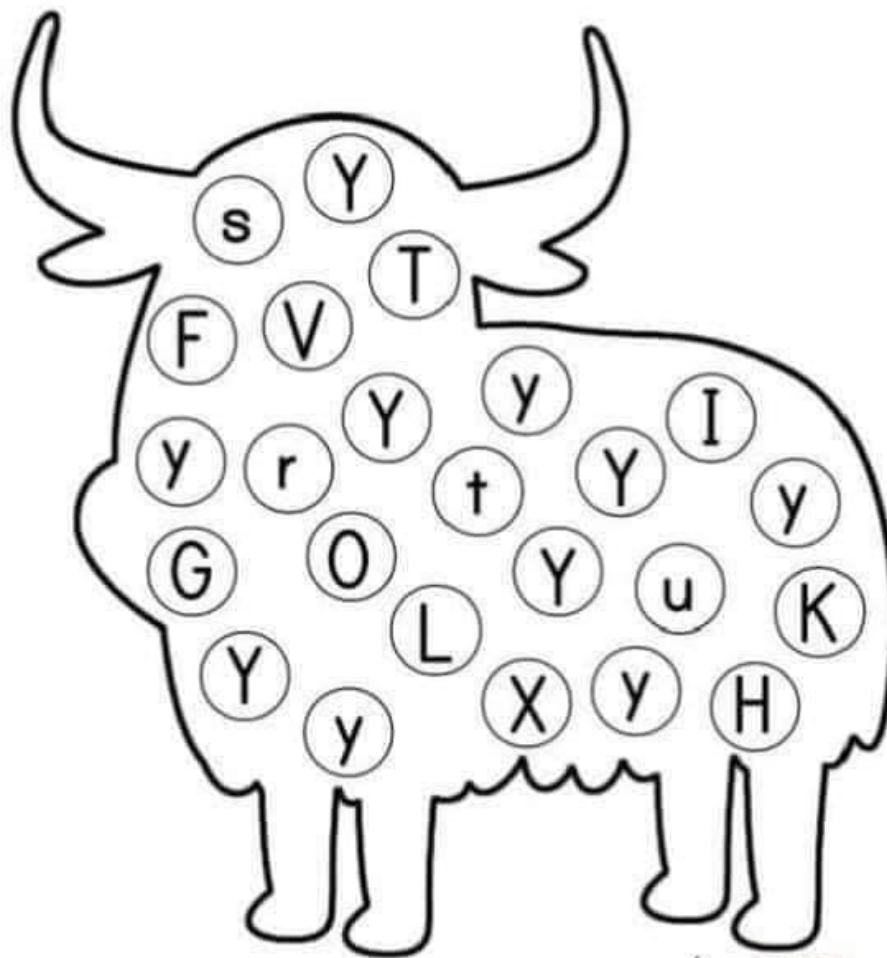

yak

Name: _____

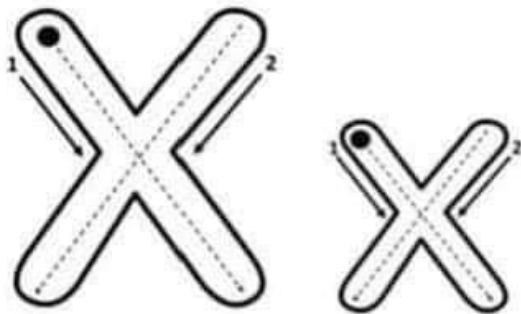
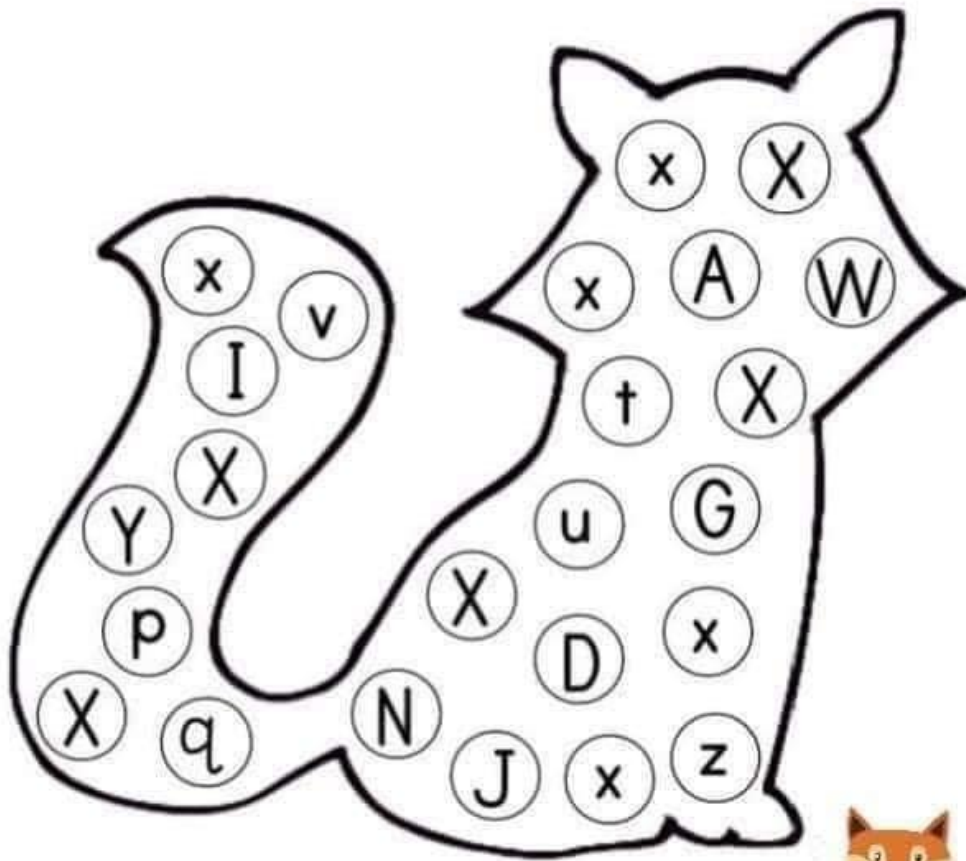

fox

Name: _____

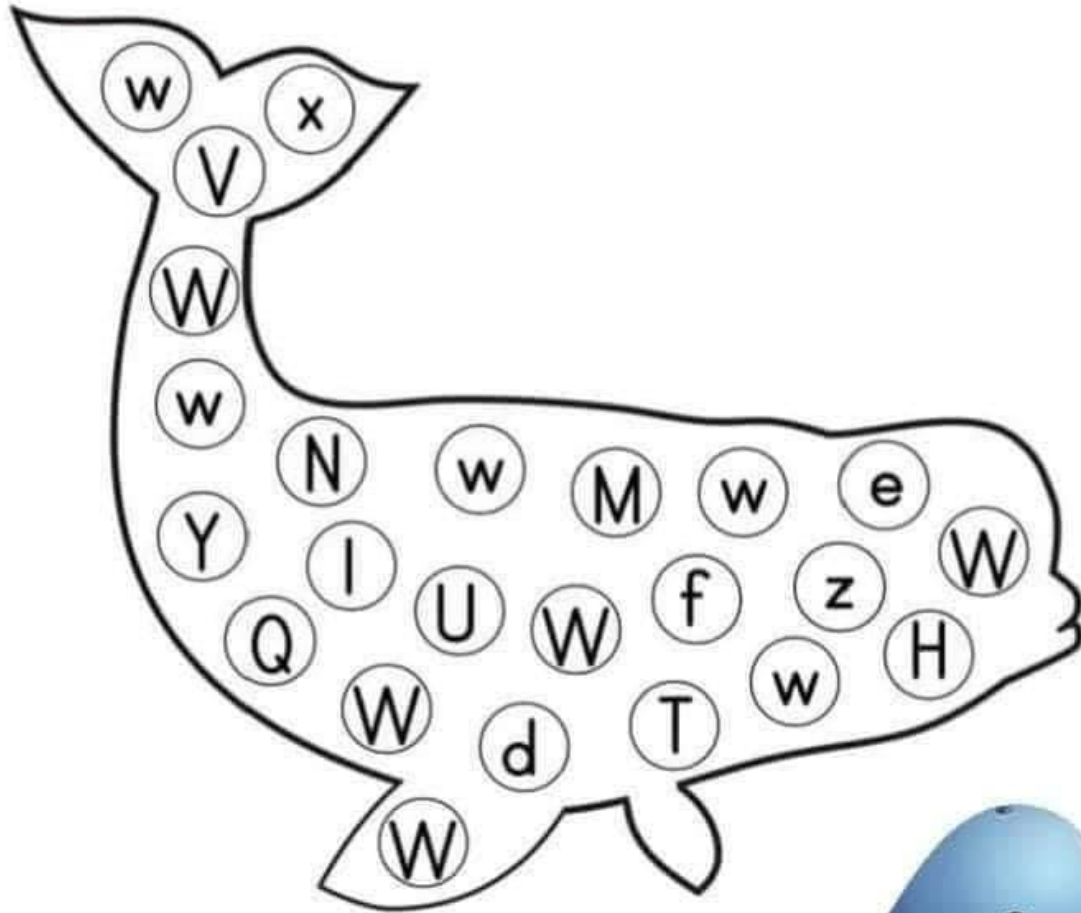

whale

Name: _____

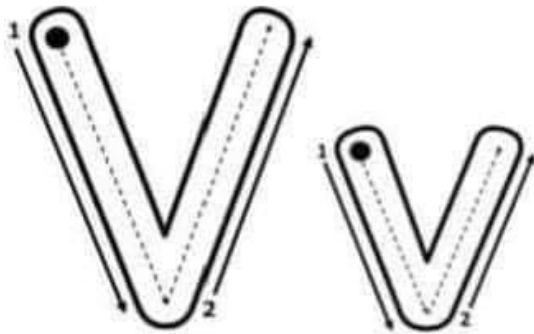
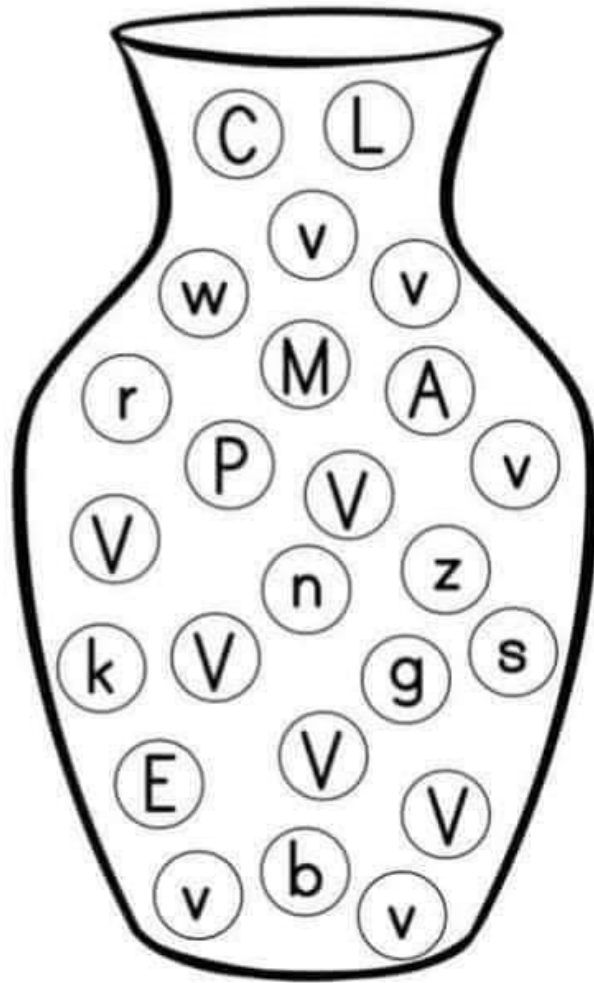

vase

Name: _____

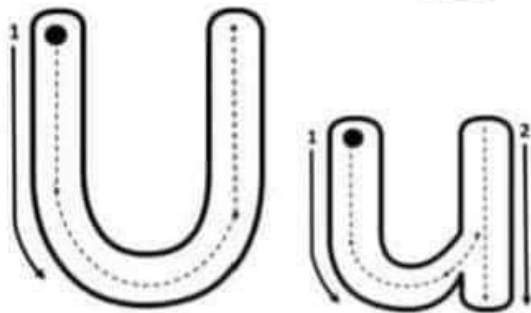
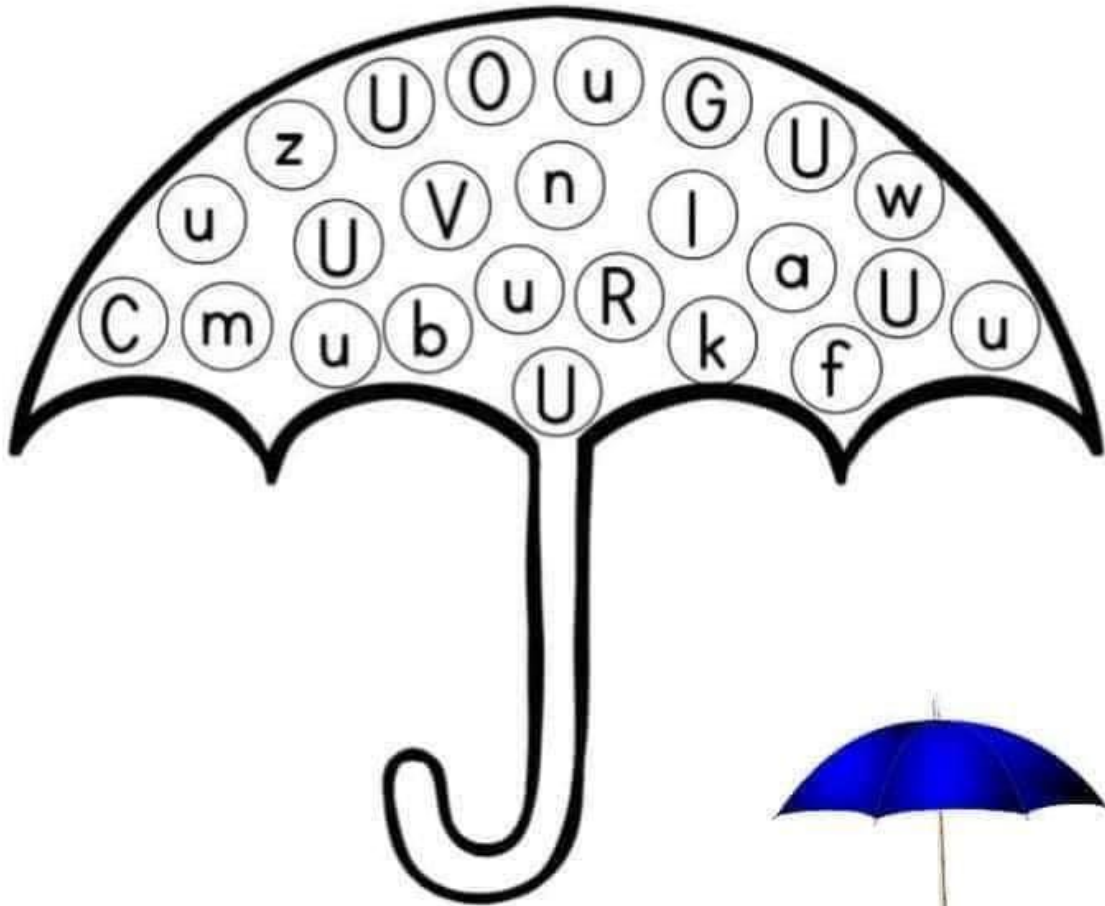

umbrella

Name: _____

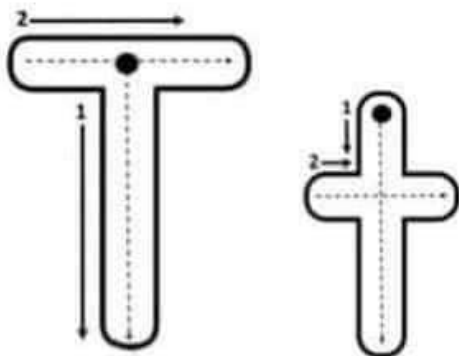
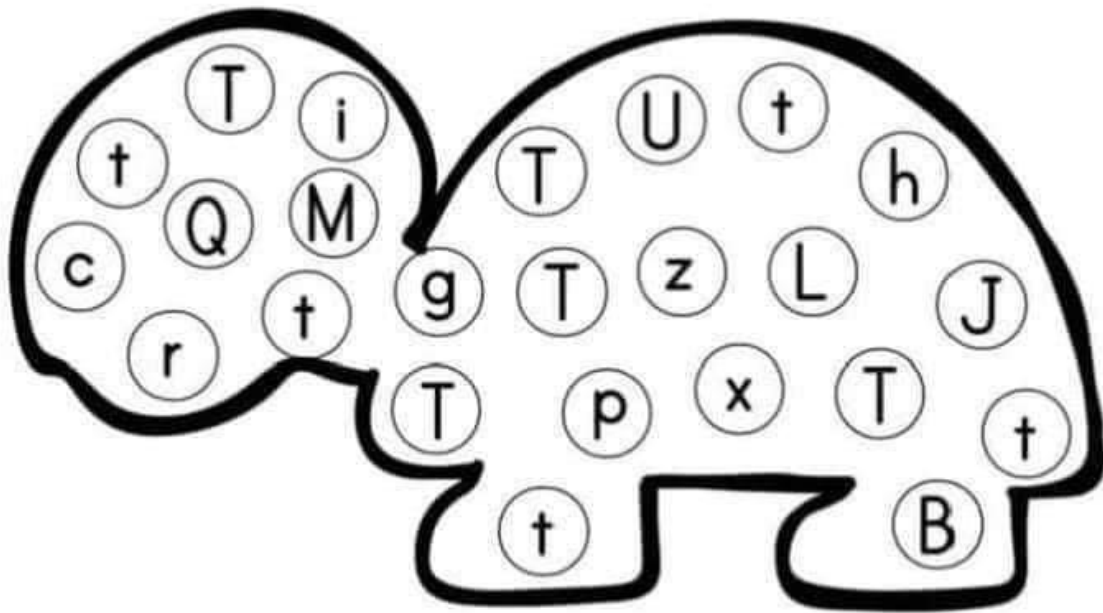

turtle

Name: _____

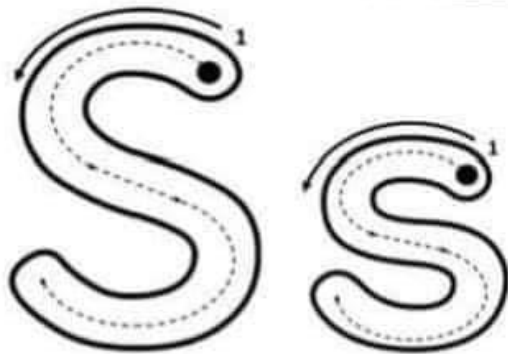
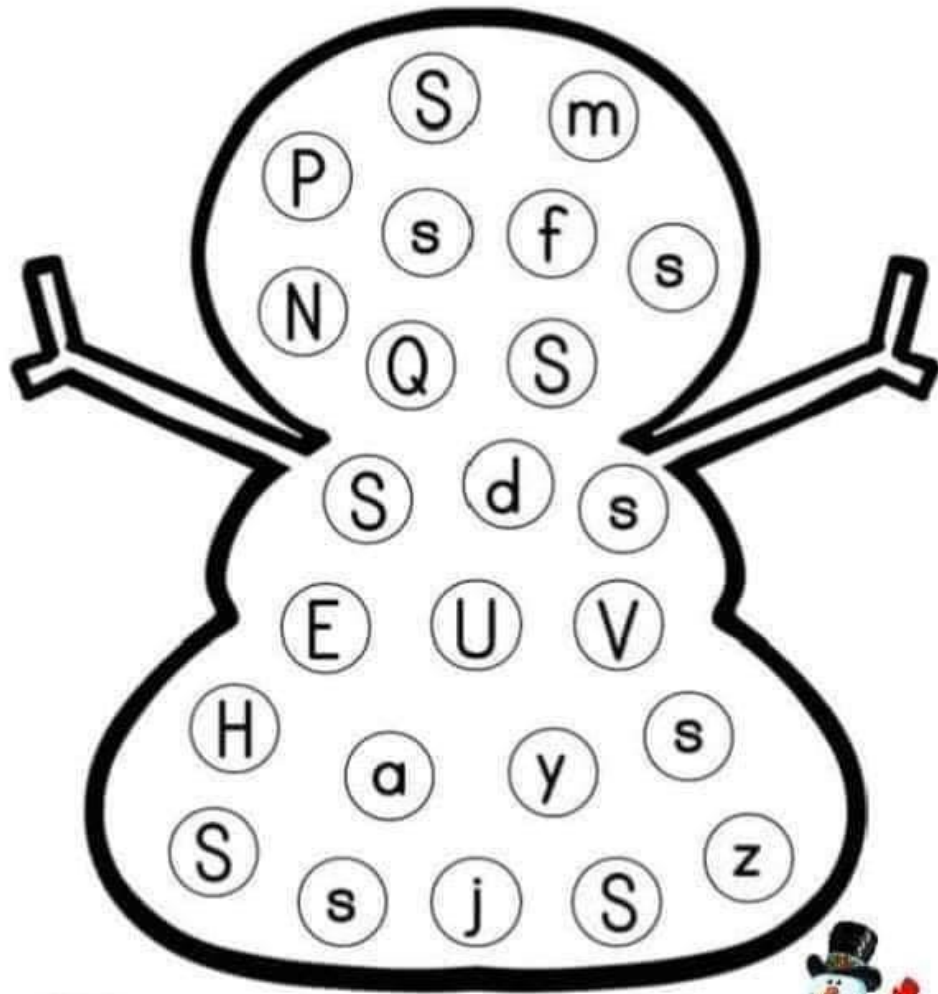

snowman

Name: _____

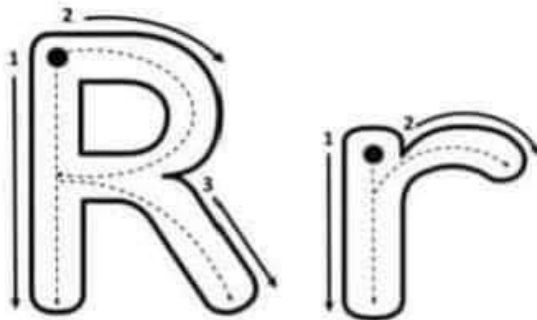
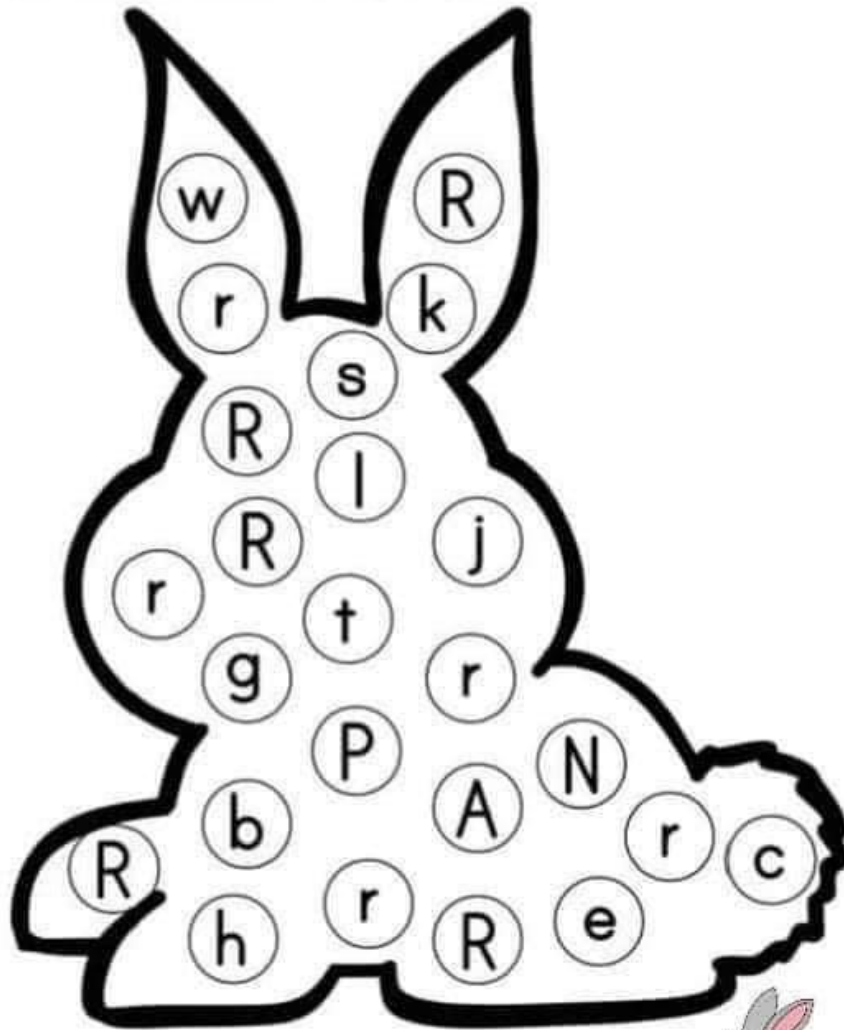

rabbit

Name: _____

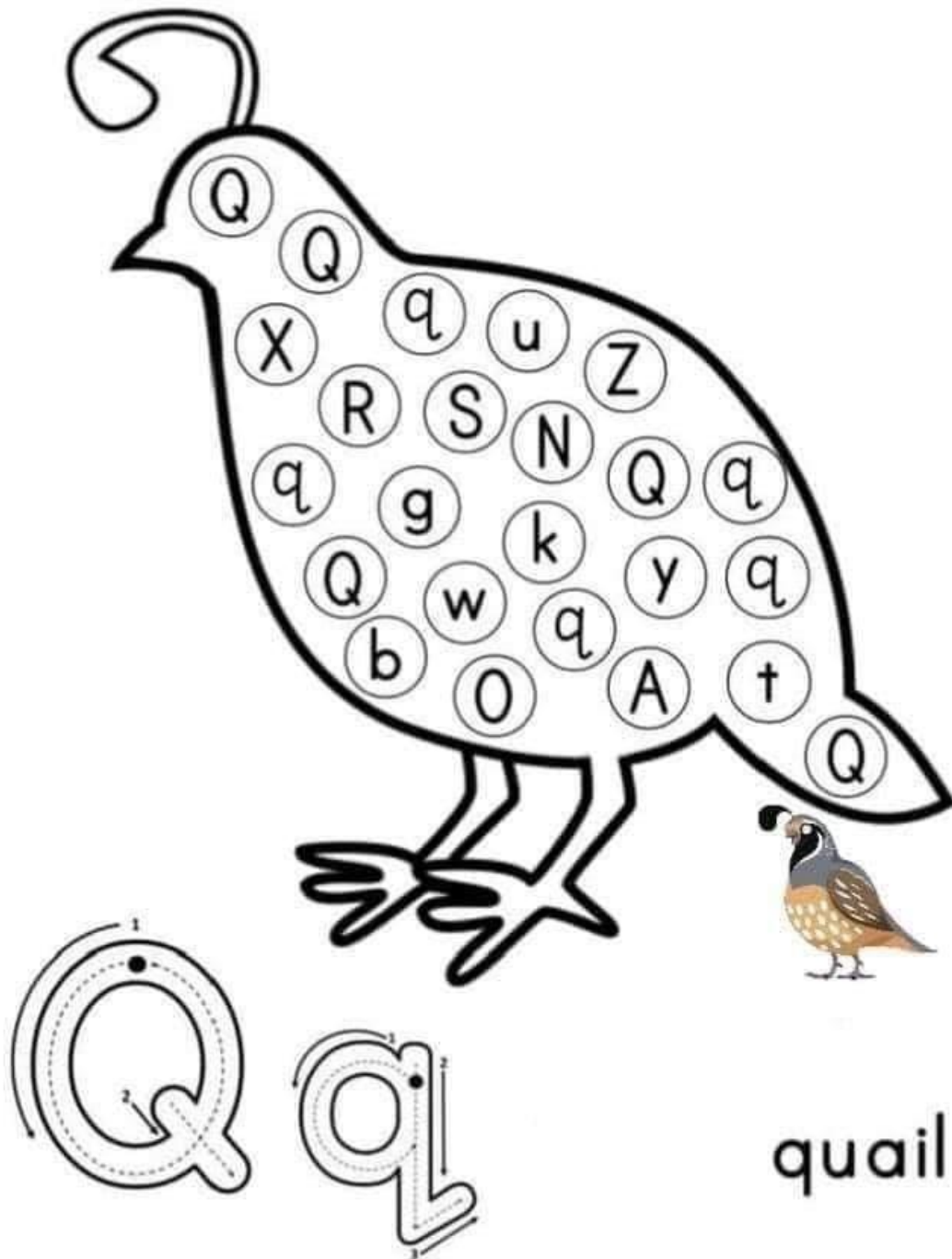

Name: _____

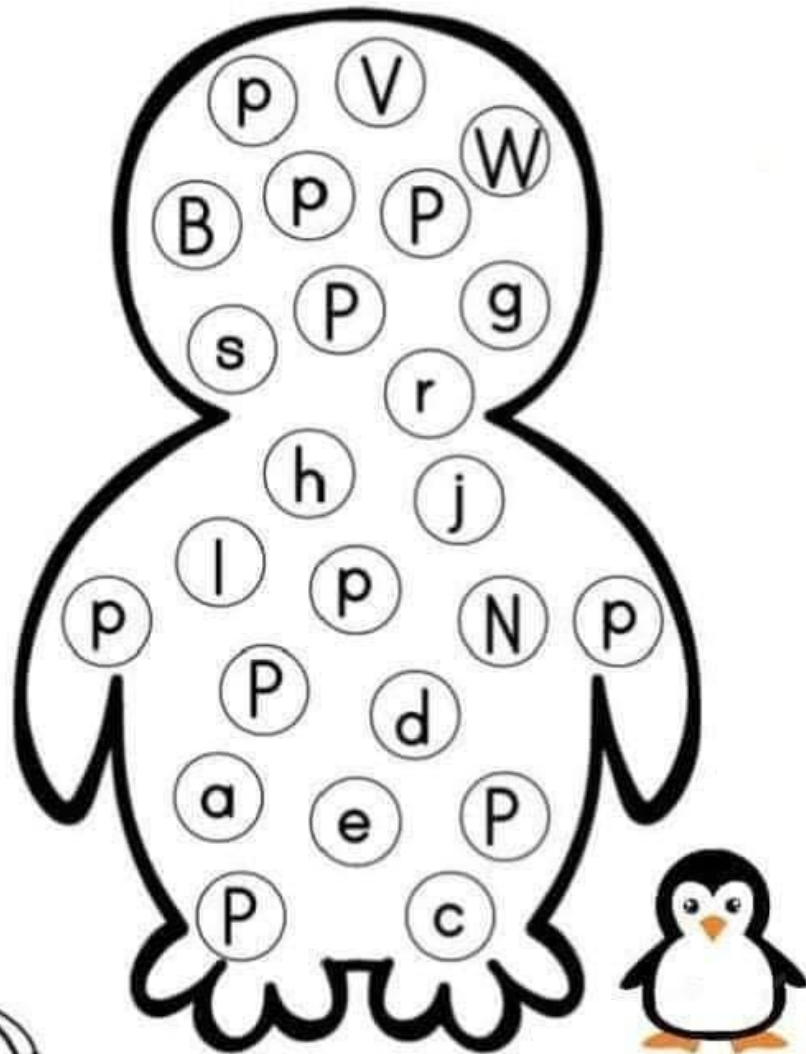

penguin

Name: _____

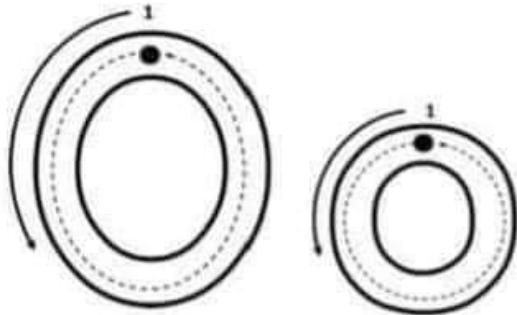
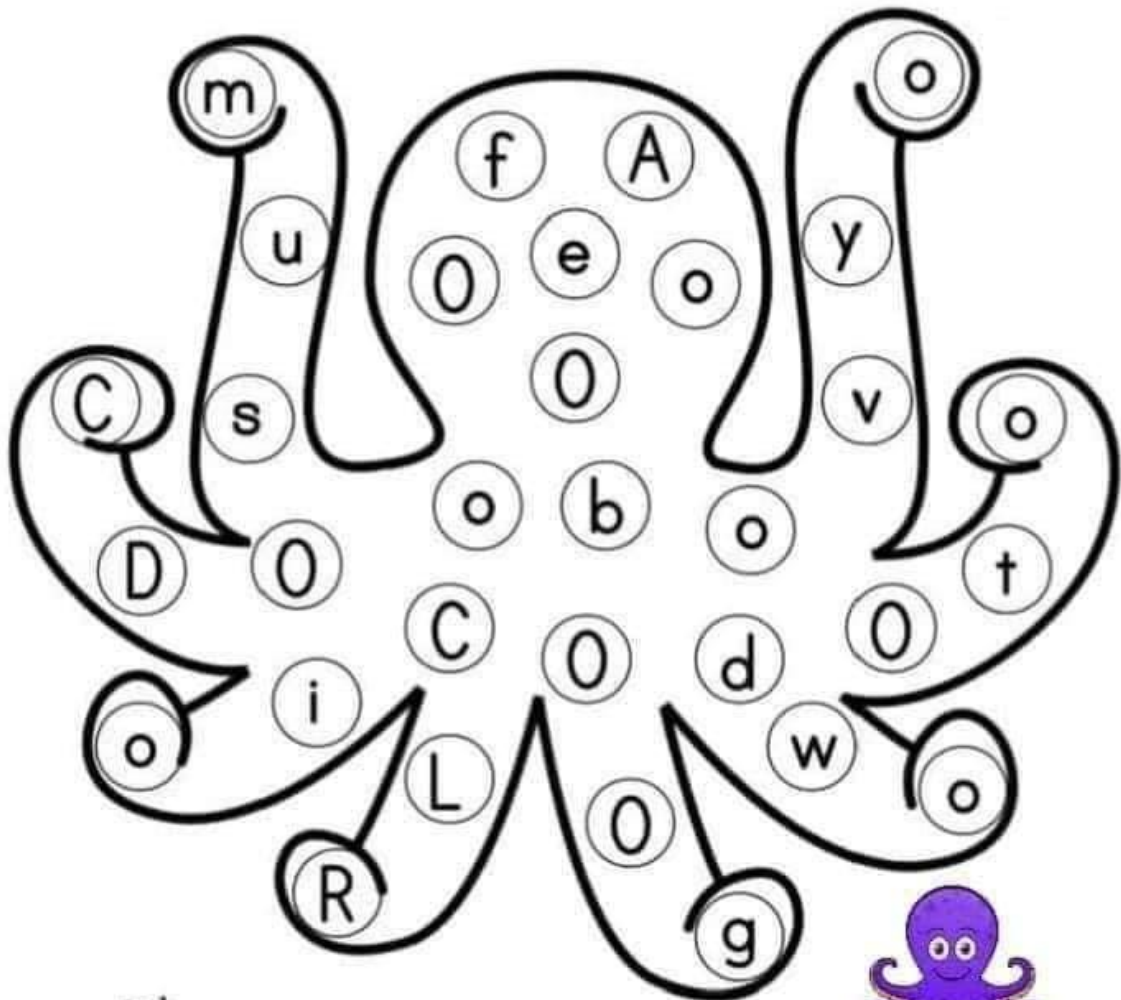

octopus

Name: _____

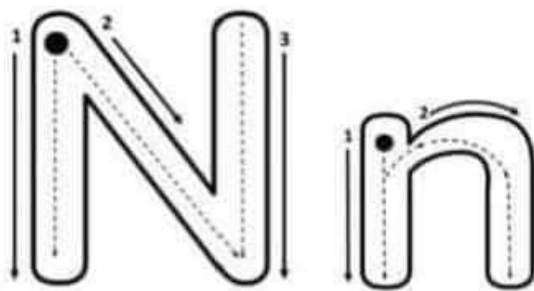
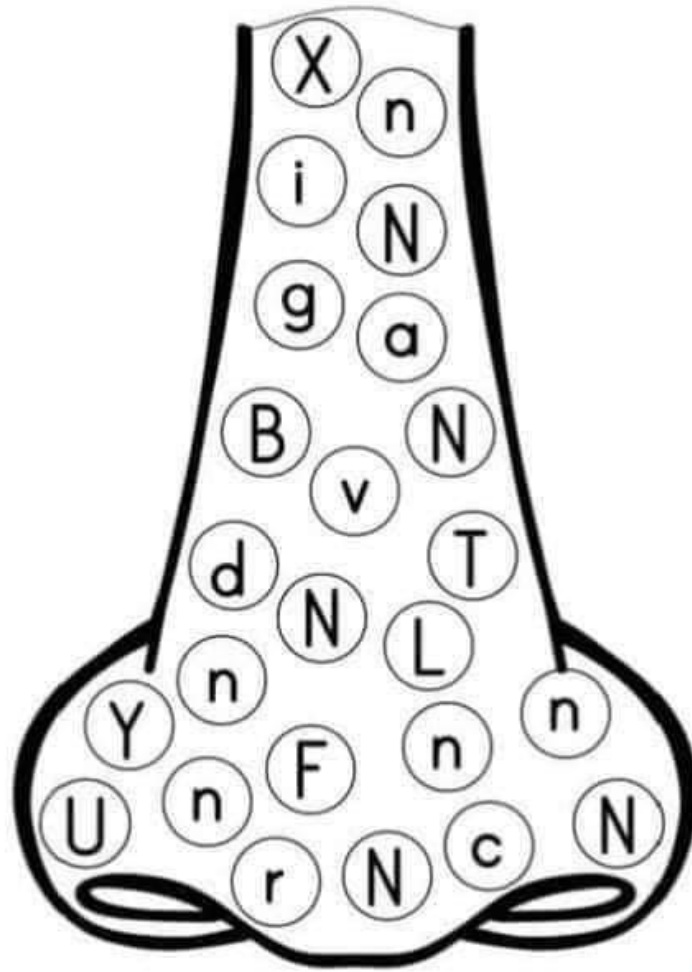

nose

Name: _____

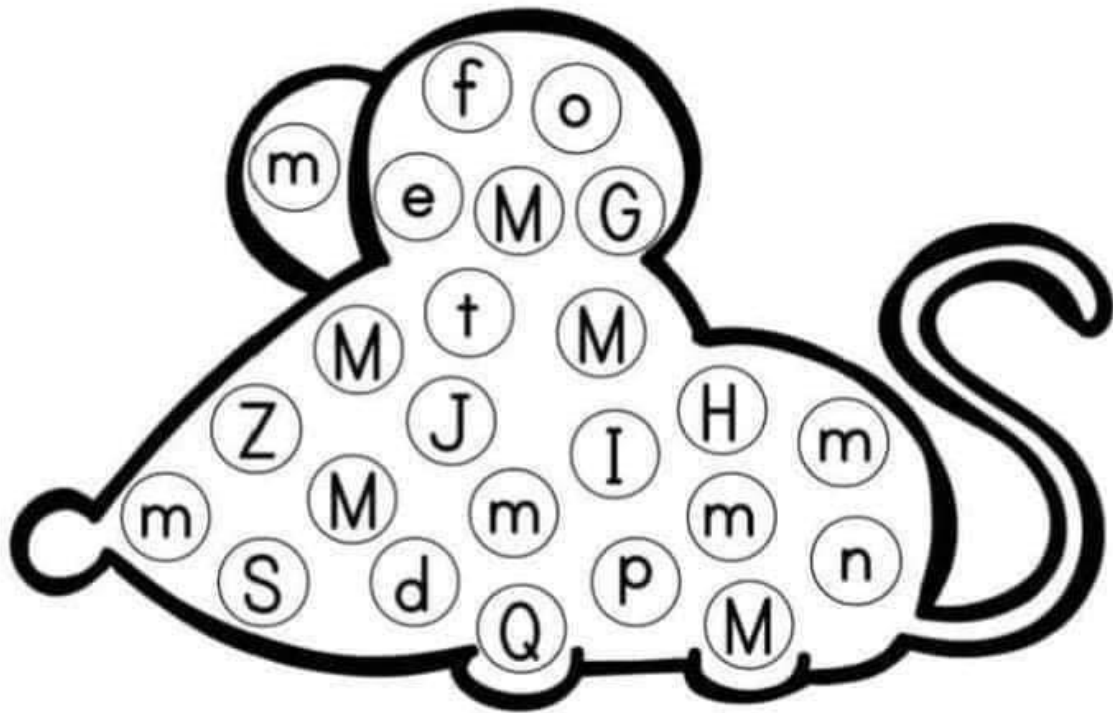

mouse

Name: _____

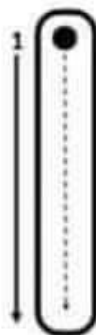
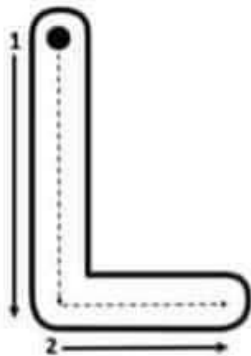
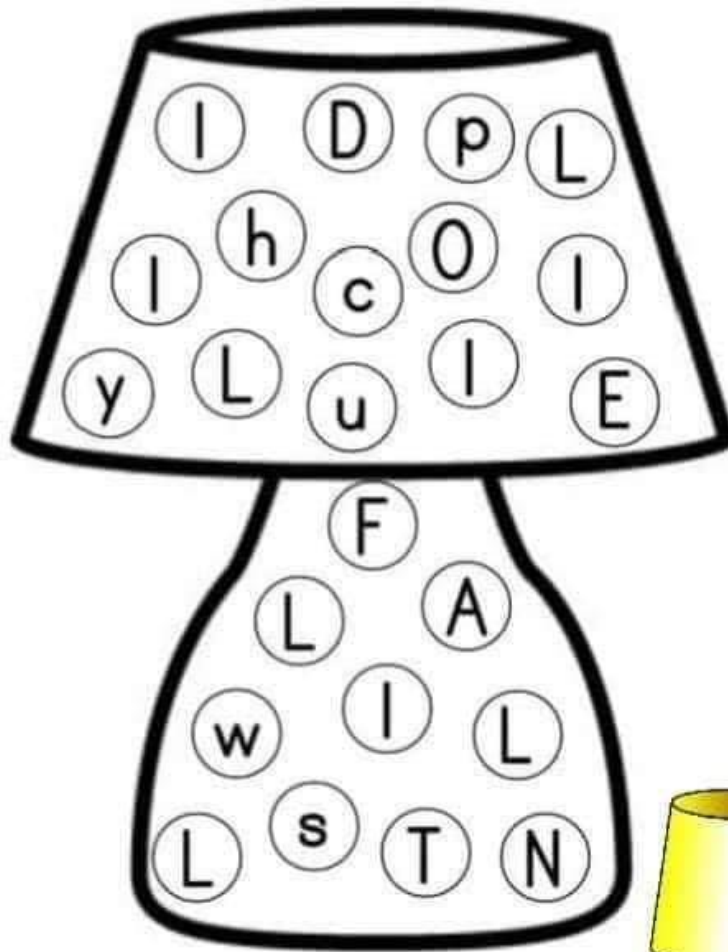

lamp

Name: _____

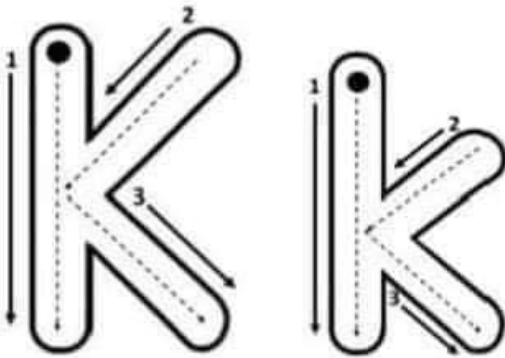
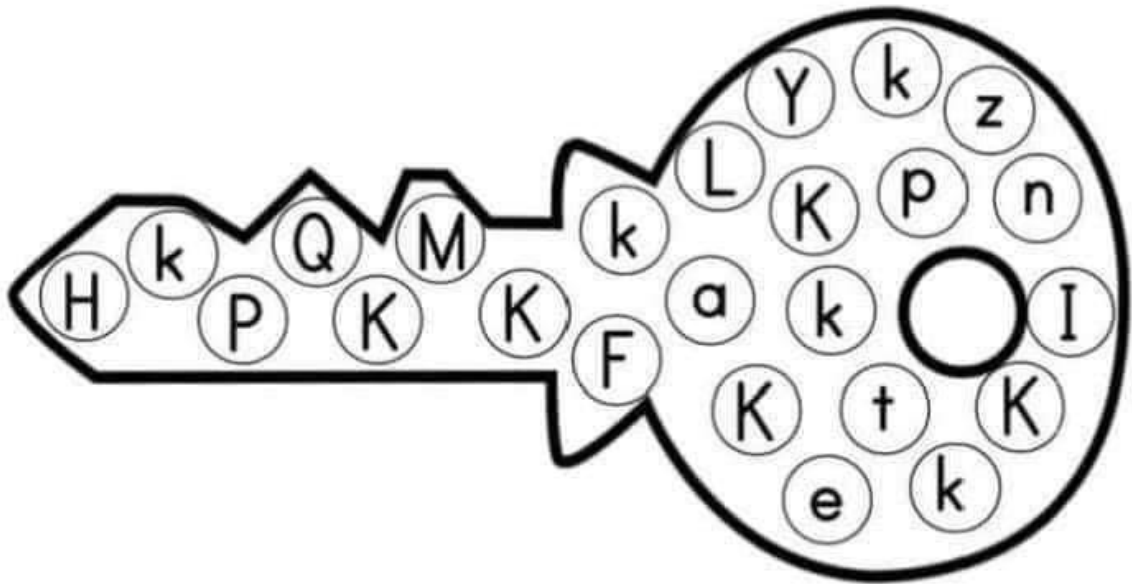

key

Name: _____

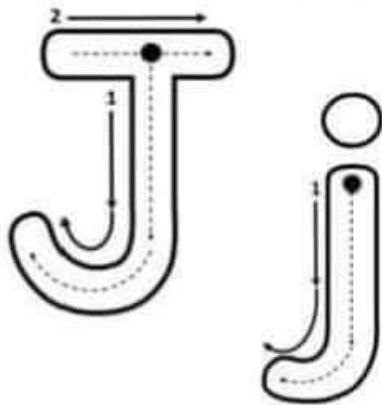
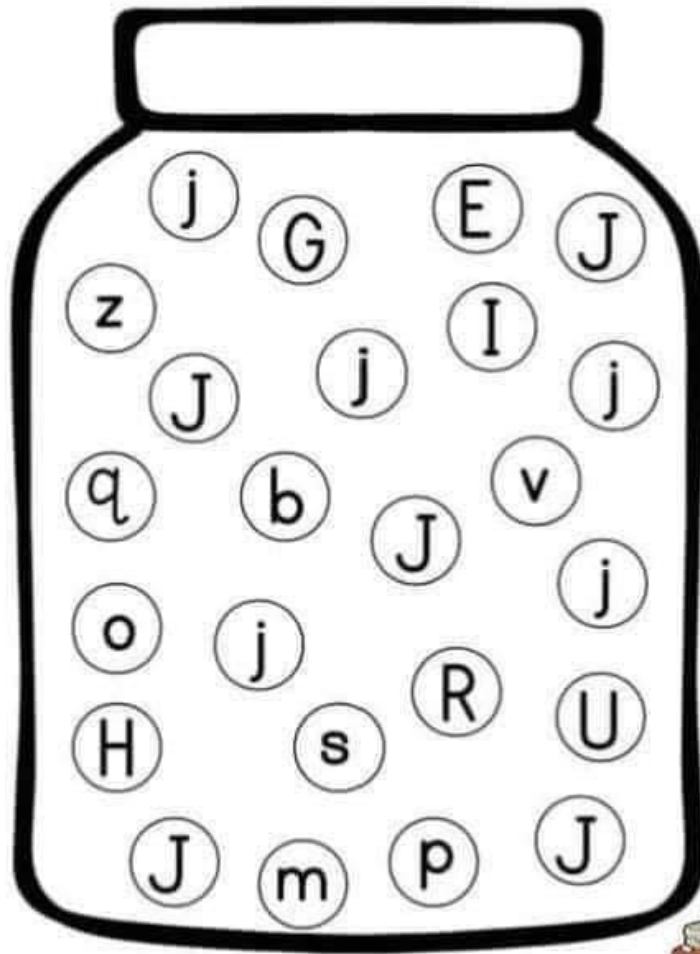

jar

Name: _____

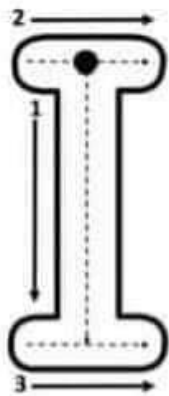
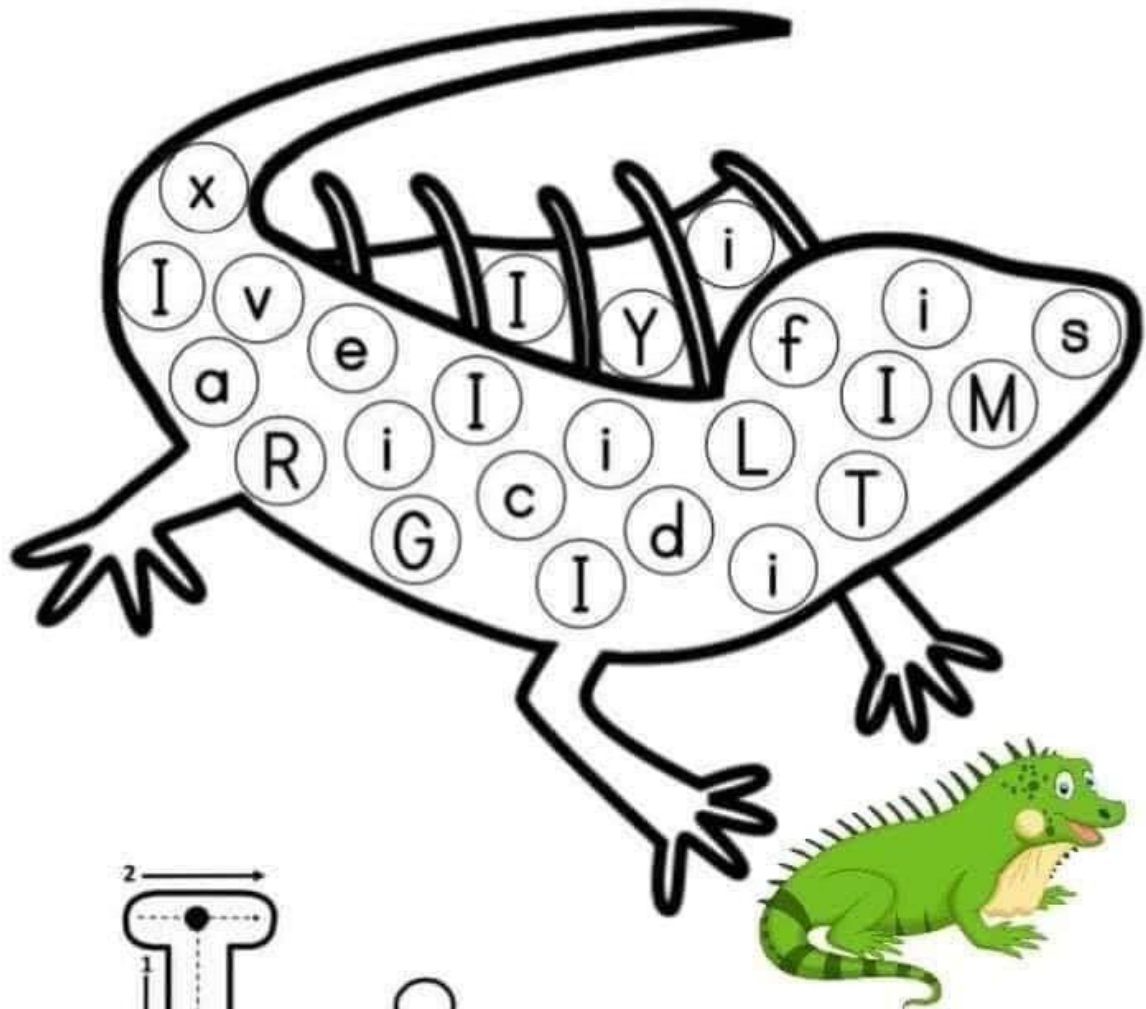

iguana

Name: _____

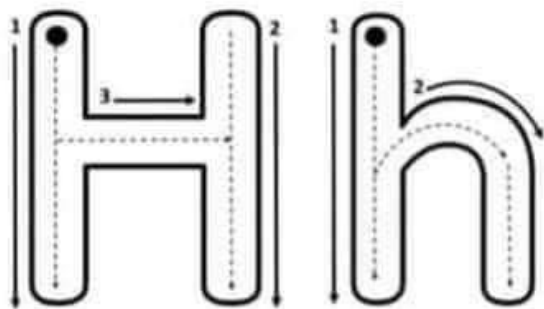
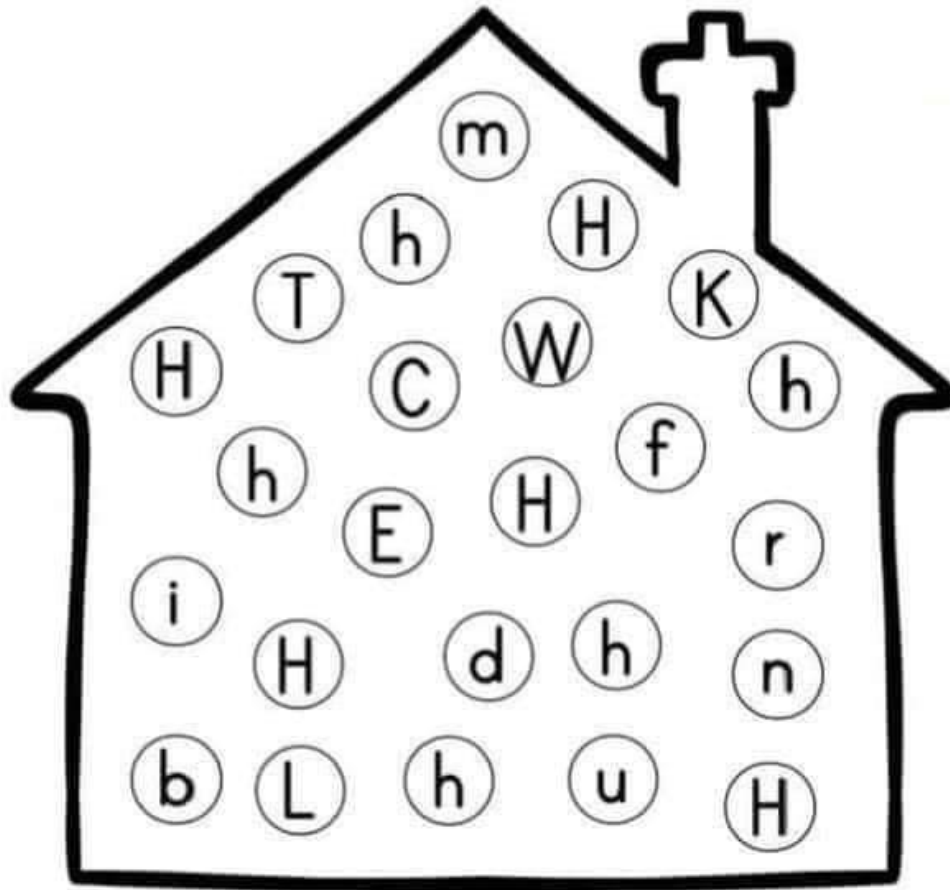

house

Name: _____

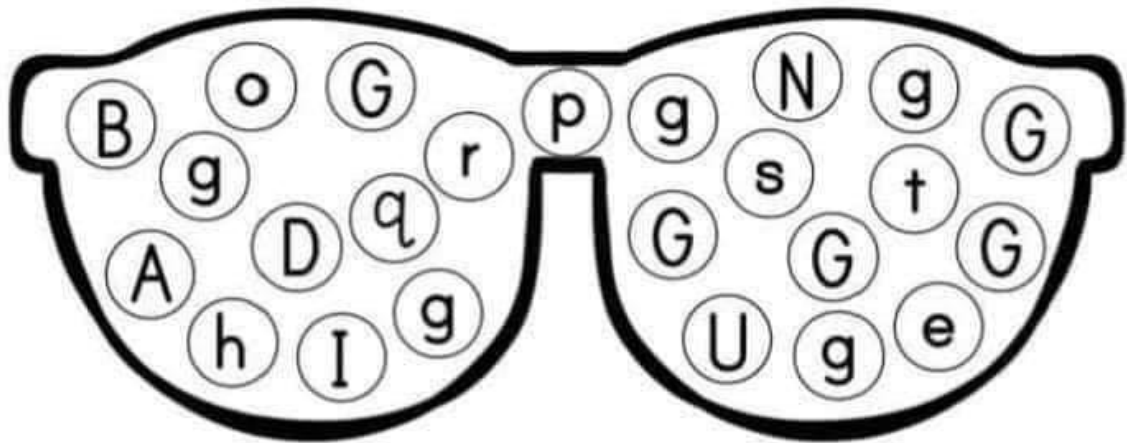

glasses

Name: _____

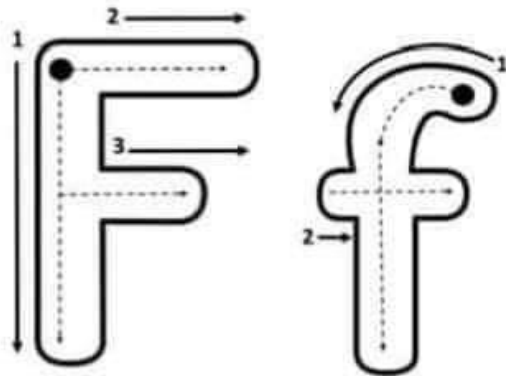
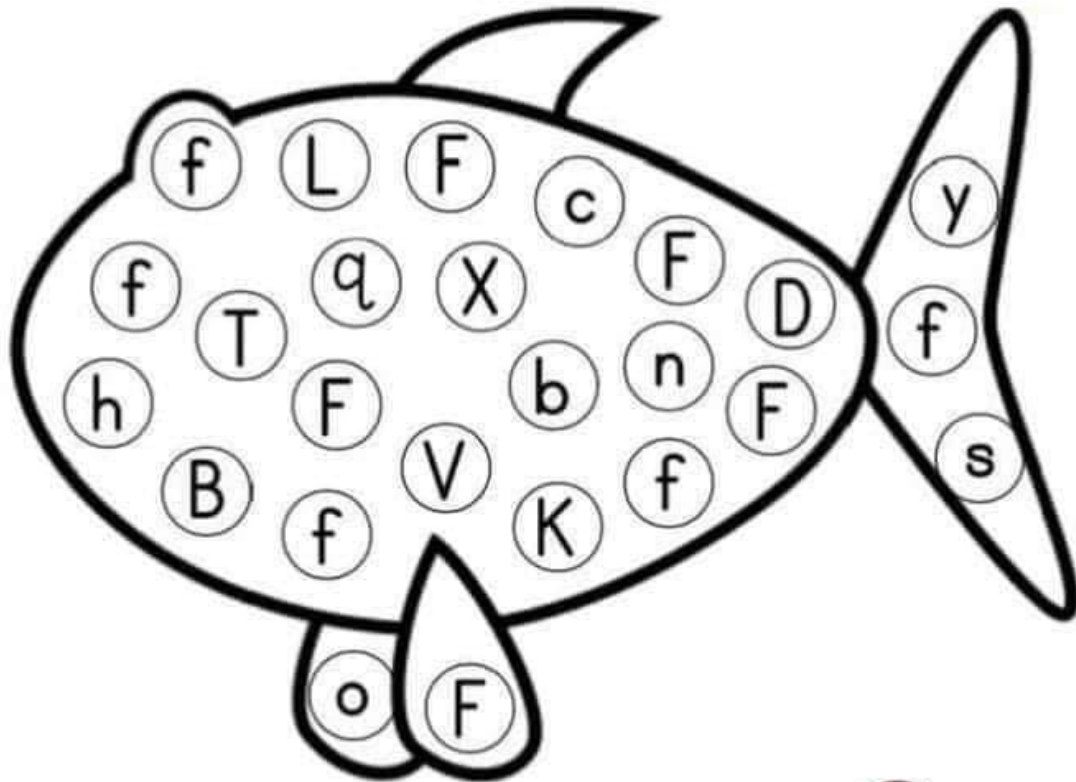

fish

Name: _____

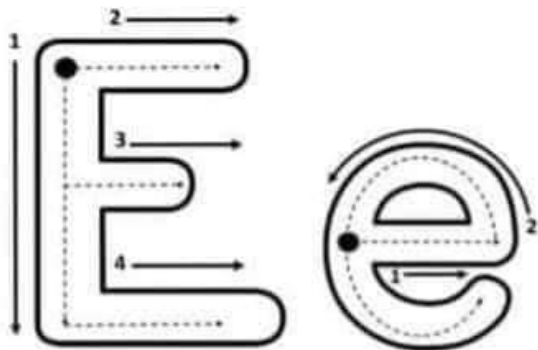
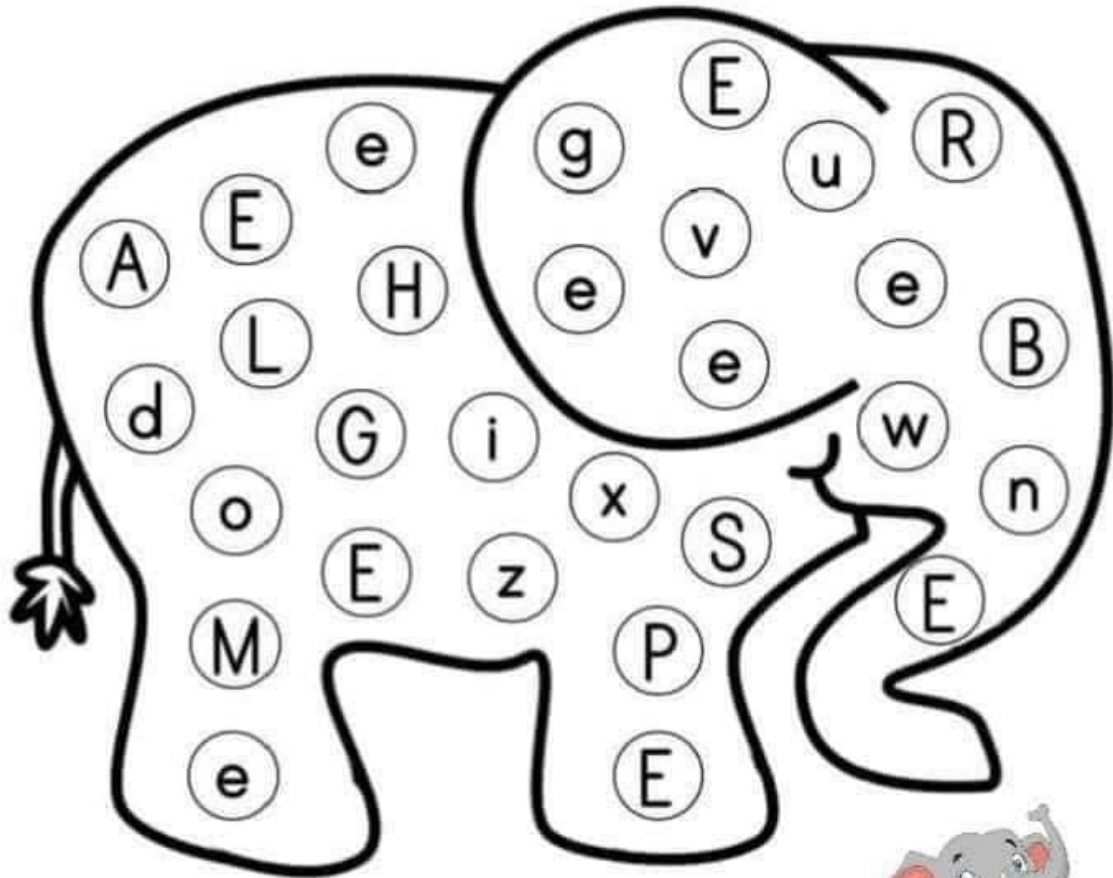

elephant

Name: _____

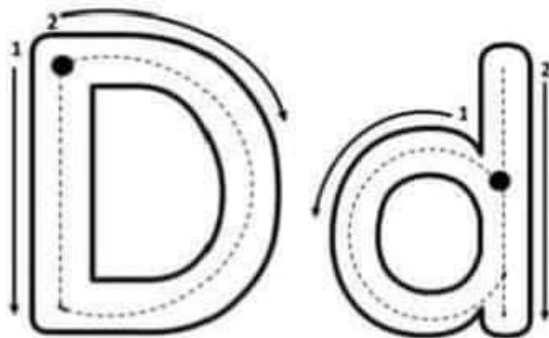
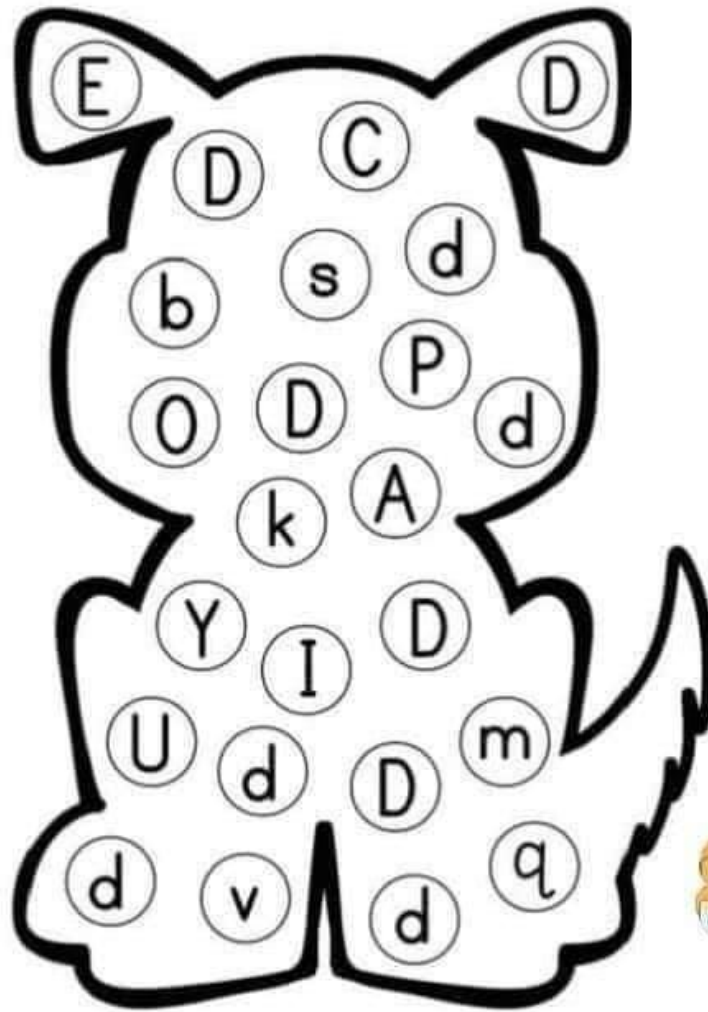

dog

Name: _____

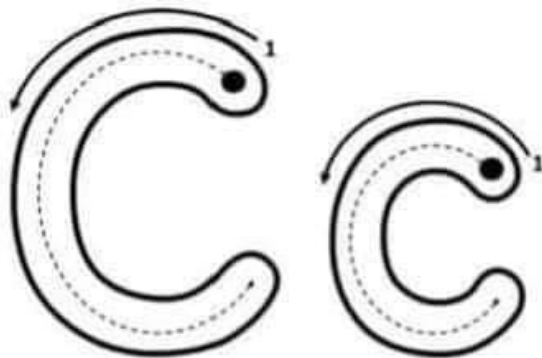
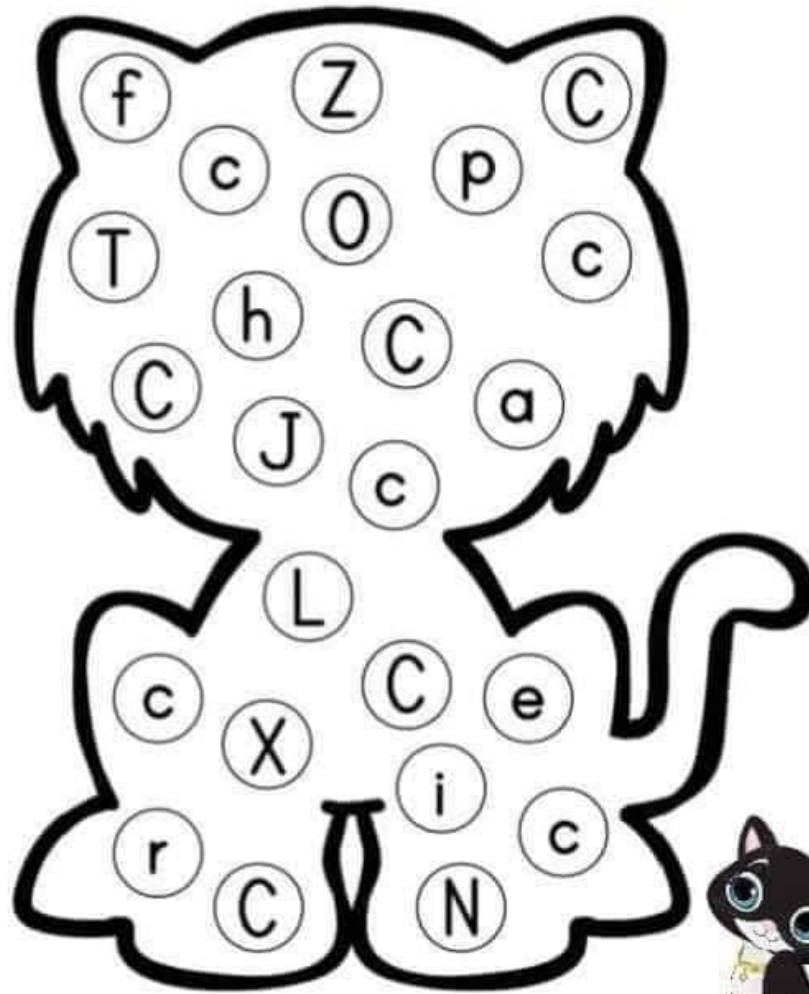

cat

Name: _____

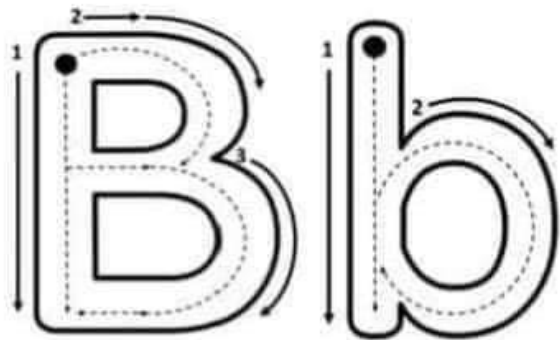
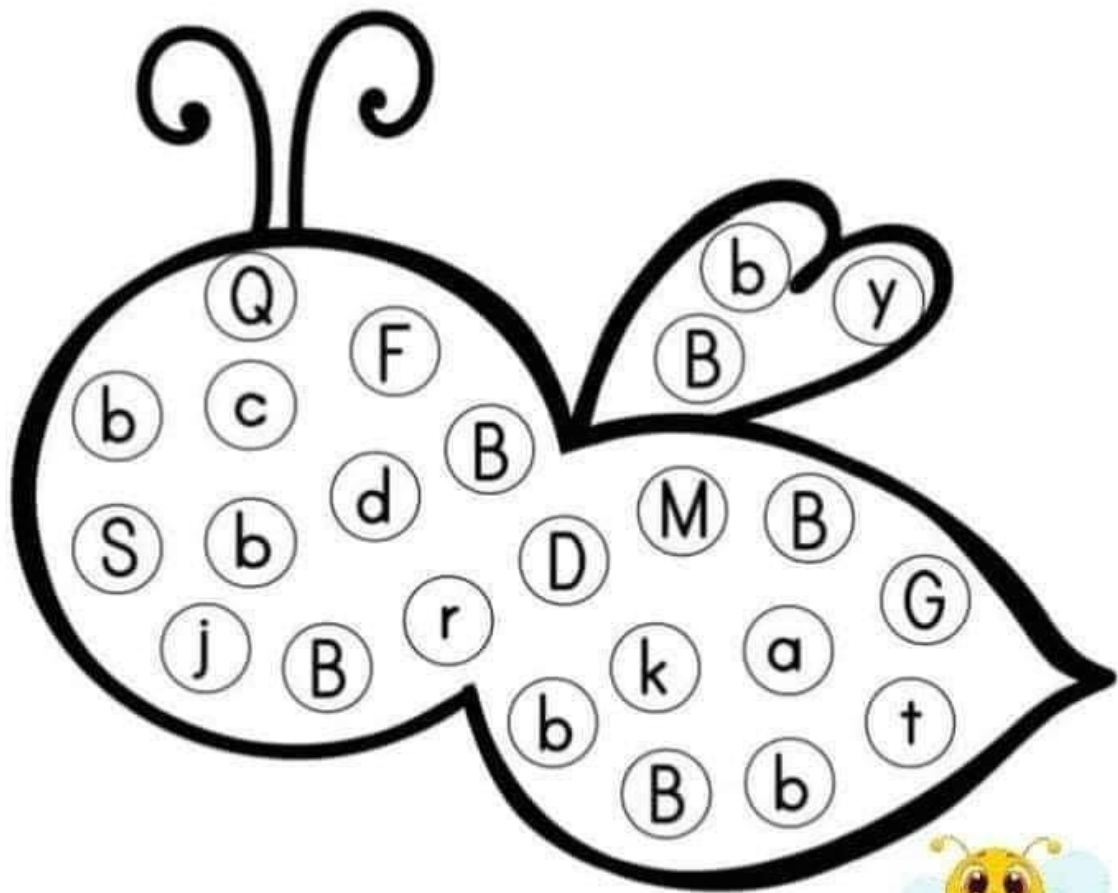

bee